

ISL85033-12VEVAL3Z Wide V_{IN} Negative V_{OUT} Buck-Boost Regulator With Up to 5A Output Current

Hardware Description

The ISL85033 is a wide input range, dual standard buck converter that can be configured to provide a negative output voltage. The ISL85033-12VEVAL3Z evaluation board is used in this application note to demonstrate the negative configuration. In this configuration, V_{IN} can range from 4.5V to $(28V - V_{OUT})$.

The ISL85033 is offered in a 4mmx4mm 28 Ld TQFN package with 1mm maximum height. The complete converter occupies 6.25cm² area.

Key Features

- Wide Input Voltage Range from 4.5V to $(28V - V_{OUT})$
- Adjustable and Synchronizable Negative Output Voltage with Continuous Output Current up to 5A, depending on V_{OUT} and V_{IN}
- Current Mode Control
- Adjustable Switching Frequency from 300kHz to 2MHz
- Power-Good Detection (referenced to V_{OUT})
- Externally Adjustable Soft-start Time
- Overcurrent and Hiccup Mode Short Circuit Protection, Thermal Overload Protection, UVLO
- Boot Undervoltage Detection
- Default Out-of-phase Channels Reduce Voltage Ripple and Component Size. User-selectable Phase Operation.

Recommended Equipment

The following materials are recommended to perform testing:

- 0V to 30V power supply with at least 7A source current capability or a 5V battery
- Electronic loads capable of sinking current up to 7A
- Digital multimeters (DMMs)
- 100MHz quad-trace oscilloscope
- Signal generator

Quick Setup Guide

1. Ensure that the circuit is correctly connected to the supply and loads prior to applying any power.
2. Connect the bias supply to VIN1, the plus terminal to VIN1, and the negative return to GND1.
3. Verify that the position is ON for S1.
4. Turn on the power supply.
5. Verify the output voltage is -12V for V_{OUT} .

Evaluating the Other Output Voltages

The ISL85033-12VEVAL3Z kit output is preset to -12V; however, output voltages can be adjusted from -3.3V to -15V. The output voltage programming resistor, R3, depends on the desired output voltage of the regulator. The value for the feedback resistor is typically between 0Ω and 142kΩ as shown in Equation 1.

$$R3 = R2 \left(\frac{V_{OUT}}{V_{FB}} - 1 \right) \quad (EQ. 1)$$

Table 1 summarizes the external component selection for $V_{OUT} = -5V$, $V_{OUT} = -12V$, and $V_{OUT} = -15V$.

TABLE 1. COMPONENT SELECTION FOR V_{OUT}

V_{OUT}	EXTERNAL COMPONENTS
-5V	R3 = 43.2k; R5 = 20k; C4 = 2.7nF C20 = 22μF (1210 ceramic) C17 = 22μF (1210 ceramic) C19 = 68μF (15mΩ polymer EEFUD0K680R)
-12V	R3 = 11.2k; R5 = 120k; C4 = 4.7nF C14, C17 = 22μF (2210 ceramic) C12, C19 = 68μF (70mΩ TaNbO2 TPSD686M020R0070) C20 = DNP
-15V	R3 = 14.2k; R5 = 120k; C4 = 4.7nF C14, C17 = 22μF (2210 ceramic) C12, C19 = 68μF (70mΩ TaNbO2 TPSD686M020R0070) C20 = DNP

The curves in Figure 1 indicate the maximum output current the converter can deliver as a function of the input voltage and the selected output voltage configuration.

Figures 2, 3 and 4 show the efficiency for different V_{IN} , V_{OUT} and load combinations.

Application Note 1636

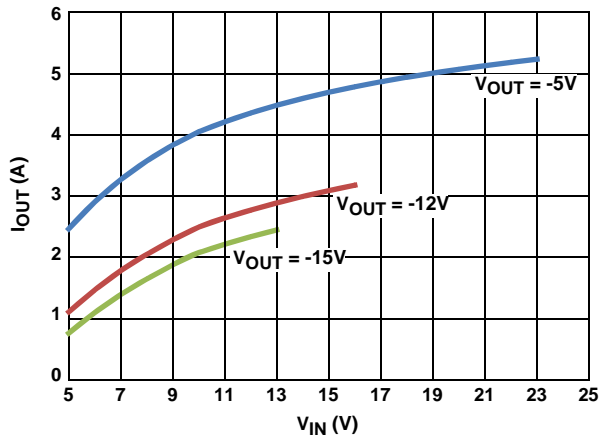

FIGURE 1. ISL85033-12VEVAL3Z BUCK BOOST: RECOMMENDED MAXIMUM I_{OUT} (V_{IN})

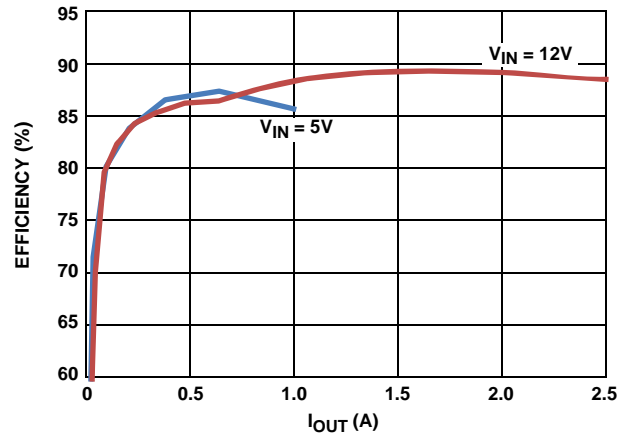

FIGURE 2. ISL85033-12VEVAL3Z EFFICIENCY: $V_{OUT} = -15V$

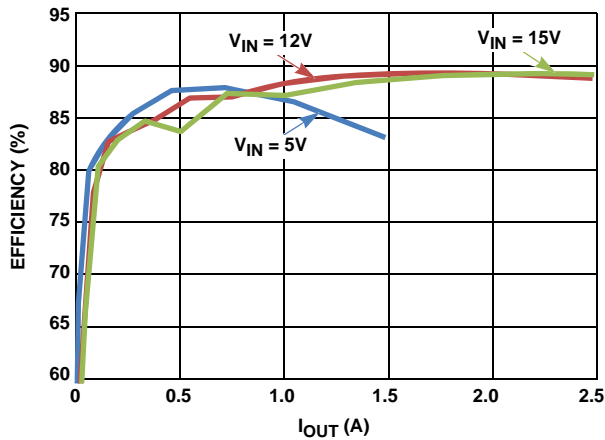

FIGURE 3. ISL85033-12VEVAL3Z EFFICIENCY: $V_{OUT} = -12V$

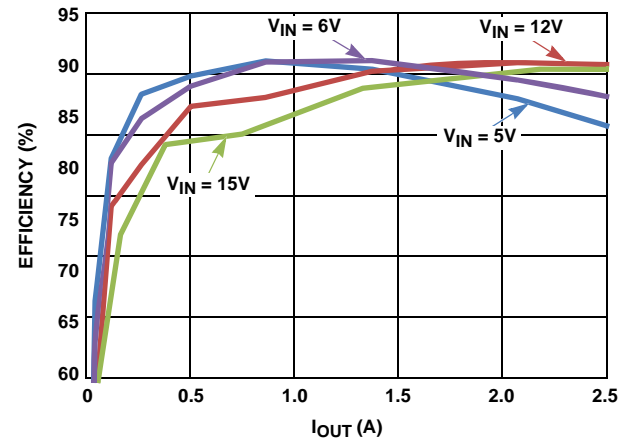

FIGURE 4. ISL85033-12VEVAL3Z EFFICIENCY: $V_{OUT} = -5V$

If the output voltage desired is $-0.8V$, then R3 is shorted. The value for R2 is typically between $1k$ and $10k$. Note that if $V_{OUT} < |2.5V|$ (i.e., $-0.8V$), the switching frequency and compensation must be changed to accommodate the $300kHz$ operation, due to minimum on-time limitation. Please refer to the [ISL85033](#) data sheet for further information.

Frequency Control

The ISL85033-12VEVAL3Z evaluation board has an FS pin that controls the frequency of operation. Programmable frequency allows for optimization between efficiency and external component size. Default switching frequency is $500kHz$ when FS is tied to VCC ($R9 = 0$). By removing R9 and connecting R10 to the most negative potential on the board (V_{OUT}), the switching frequency could be changed from $300kHz$ ($R10 = 383k$) to $2MHz$ ($R10 = 40.2k$). See the [ISL85033](#) data sheet for information about calculating the value of R10. Do not leave this pin floating.

Disabling/Enabling Function

The ISL85033-12VEVAL3Z evaluation board contains an S1 switch that enables or disables both channels, thus allowing a low quiescent current state. Table 2 details this function.

TABLE 2. SWITCH SETTINGS

S1	ON/OFF CONTROL
ON	Enable V_{OUT}
OFF	Disable V_{OUT}

NOTE: If driven externally, the EN signal (the same as all input logic signals) is referenced to V_{OUT} (the most negative potential on the board) and not to GND. Therefore, the source cannot be GND referenced, and input level shifting is required.

ISL85033-12VEVAL3Z Schematic

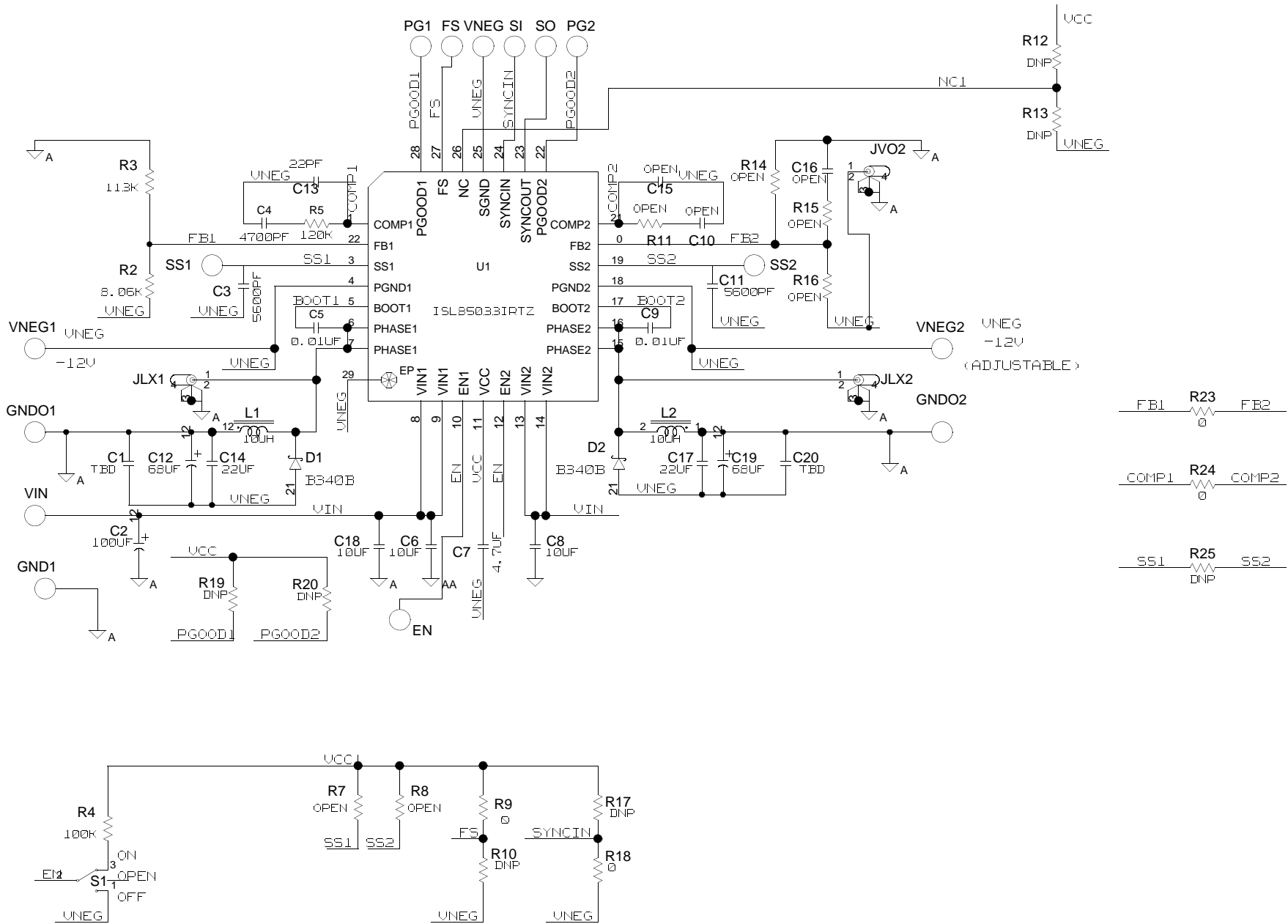

Application Note 1636

Bill of Materials

PART NUMBER	REFERENCE DESIGNATOR	QUANTITY	VALUE	TOLERANCE	VOLTAGE	POWER	PACKAGE TYPE	JEDEC TYPE	MANUFACTURER	DESCRIPTION
131-4353-00	JLX1, JLX2, JV02	3					CONN	TEK131-4353-00	TEKTRONIX	Scope Probe Test Point PCB Mount
TPSD686K020R00070-T	C12, C19	2	68µF	20%	20V		SMD	CAP_TANT	AVX	TQC Series Hi-Volt Low ESR Capacitor
B340B	D1, D2	2					SMD2	DO_SMA	DIODES	3A Low VF SCHOTTKY BARRIER RECTIFIER
C5750X7R1E226M	C14, C17	2	22µF	20%	25V		2220	CAP_2220	TDK	Ceramic Cap
EEE-FK1V101P-T	C2	1	100µF	20%	35V		SMD	CAPAE_315X402	PANASONIC	AL LYTIC FK SERIES CAP (RoHS COMP.)
GMK325BJ106KN	C6, C8	2	10µF	10%	35V		1210	CAP_1210	TAIYO YUDEN	Ceramic Chip Cap
GT13MCBE	S1	1					SW	SW_GT13MCBE	C&K	SPDT On-Off-On Ultraminiature Toggle Switch
H1044-00220-50V5	C13	1	22PF	5%	50V		402	CAP_0402	GENERIC	Multilayer Cap
H1044-00472-50V10	C4	1	4700PF	10%	50V		402	CAP_0402	GENERIC	Multilayer Cap
H1044-OPEN	C10, C15, C16	3	OPEN	OPEN	OPEN		402	CAP_0402	GENERIC	Multilayer Cap
H1045-00103-50V10	C5, C9	2	0.01µF	10%	50V		603	CAP_0603	GENERIC	Multilayer Cap
H1045-00562-50V10	C3, C11	2	5600PF	10%	50V		603	CAP_0603	GENERIC	Multilayer Cap
H1046-00475-10V20	C7	1	4.7µF	20%	10V		805	CAP_0805	GENERIC	Multilayer Cap
H1065-00106-25V10-T	C18	1	10µF	10%	25V		SMD	CAP_1206	VENKEL	Multilayer Cap
H1082-TBD-TBD	C1, C20	2	TBD	TBD	TBD		1210	CAP_1210	GENERIC	Ceramic Chip Cap
H2505-01003-1/16WR1	R4	1	100k	0.10%		1/16W	603	RES_0603	GENERIC	Metal Film Chip Resistor
H2505-DNP-DNP-1	R10, R17	2	DNP	1%		DNP	603	RES_0603	GENERIC	Metal Film Chip Resistor (Do Not Populate)
H2505-DNP-DNP-R1	R12, R13, R19, R20, R25	5	DNP	0.10%		DNP	603	RES_0603	GENERIC	Metal Film Chip Resistor (Do Not Populate)
H2510-01133-1/16W1	R3	1	113k	1%		1/16W	402	RES_0402	GENERIC	Thick Film Chip Resistor
H2510-01203-1/16W1	R5	1	120k	1%		1/16W	402	RES_0402	GENERIC	Thick Film Chip Resistor
H2510-08061-1/16W1	R2	1	8.06k	1%		1/16W	402	RES_0402	GENERIC	Thick Film Chip Resistor
H2510-ROPEN-OPEN	R7, R8, R11, R14-R16	6	OPEN	1%		OPEN	402	RES_0402	GENERIC	Thick Film Chip Resistor
H2511-00R00-1/16W	R23, R24	2	0	0%		1/16W	603	RES_0603	GENERIC	Thick Film Chip Resistor
H2511-00R00-1/16W1	R9, R18	2	0	1%		1/16W	603	RES_0603	GENERIC	Thick Film Chip Resistor
ISL85033IRTZ	U1	1					QFN	QFN28_157X157_157_EP	INTERSIL	WIDE VIN DUAL STANDARD BUCK REGULATOR (Pb-FREE)
PAD_100	EN, FS, SI, SO, PG1, PG2, SS1, SS2, VNEG	9					THOLE	PAD-100	GENERIC	0.100 Pad with 0.037 Plated Thru Hole

Bill of Materials (Continued)

PART NUMBER	REFERENCE DESIGNATOR	QUANTITY	VALUE	TOLERANCE	VOLTAGE	POWER	PACKAGE TYPE	JEDEC TYPE	MANUFACTURER	DESCRIPTION
PAD_150	VIN, GND1, GND01, GND02, VNEG1, VNEG2	6					THOLE	PAD-150	GENERIC	0.150 Pad with 0.110 Plated Thru Hole
SQ1004	L1, L2	2	10µH	25%		4.8A	SMD	IND_SQ10XX	FALCO	SMT SHIELDED POWER INDUCTOR

ISL85033-12VEVAL3Z Layout

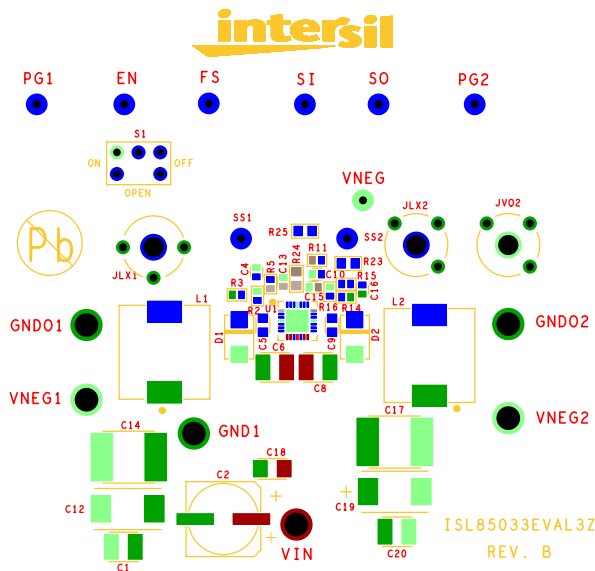

FIGURE 5. TOP LAYER COMPONENTS

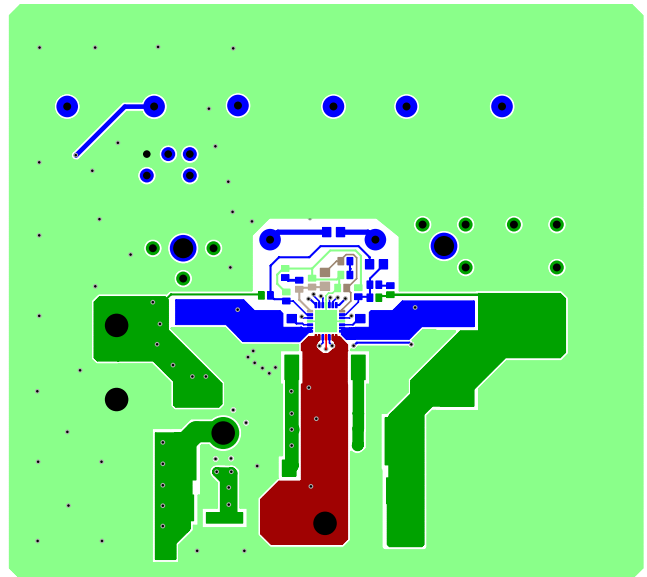

FIGURE 6. TOP LAYER ETCH

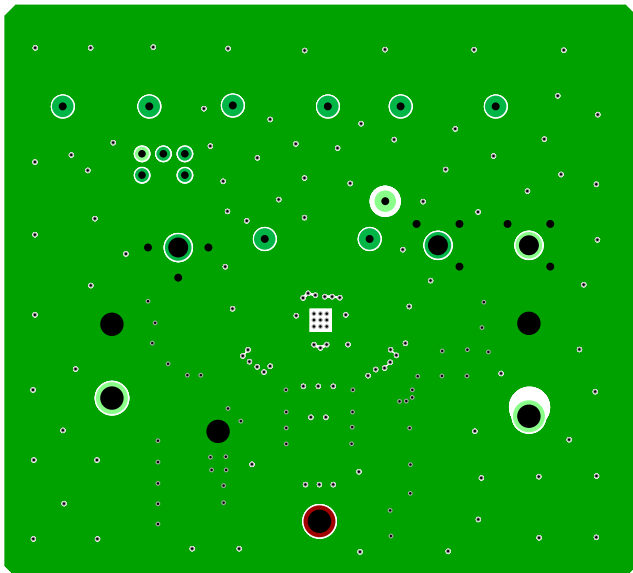

FIGURE 7. SECOND LAYER ETCH

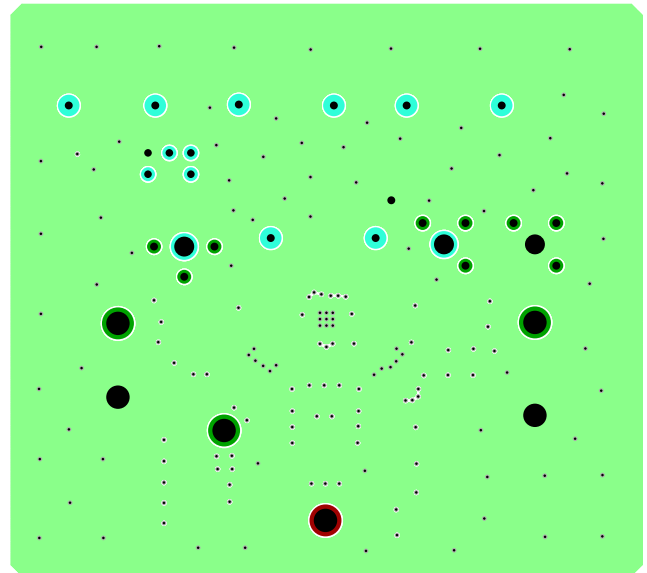

FIGURE 8. THIRD LAYER ETCH

ISL85033-12VEVAL3Z Layout (Continued)

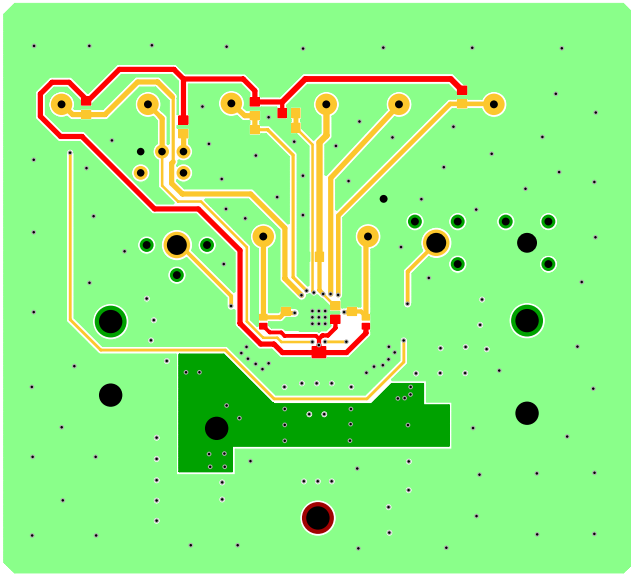

FIGURE 9. BOTTOM LAYER ETCH

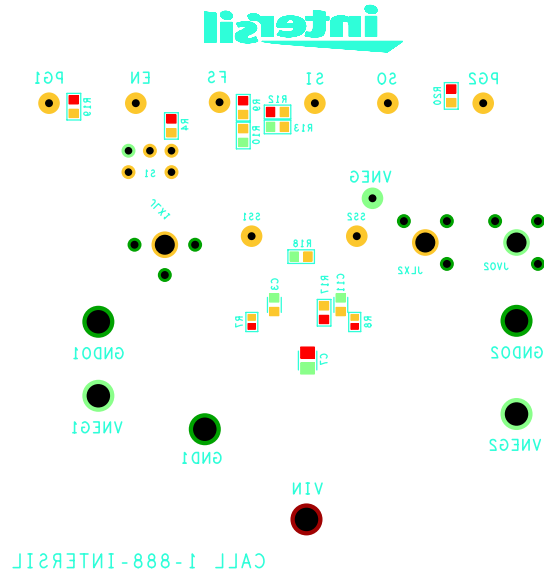

FIGURE 10. BOTTOM LAYER COMPONENTS

Intersil Corporation reserves the right to make changes in circuit design, software and/or specifications at any time without notice. Accordingly, the reader is cautioned to verify that the Application Note or Technical Brief is current before proceeding.

For information regarding Intersil Corporation and its products, see www.intersil.com